

FLOOR CABINET

ASSEMBLY INSTRUCTIONS

PLEASE RETAIN THESE INSTRUCTIONS FOR FUTURE USE

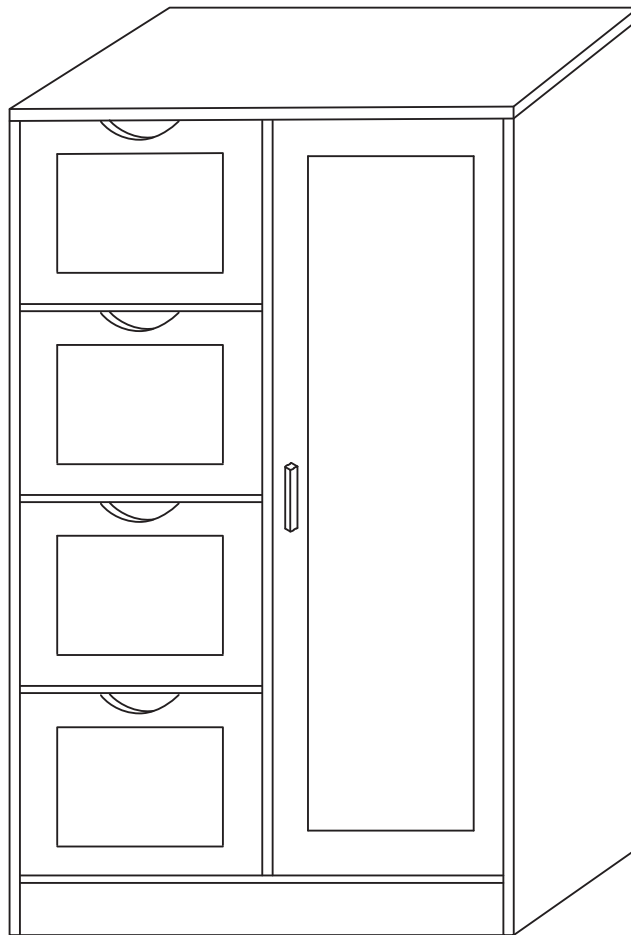

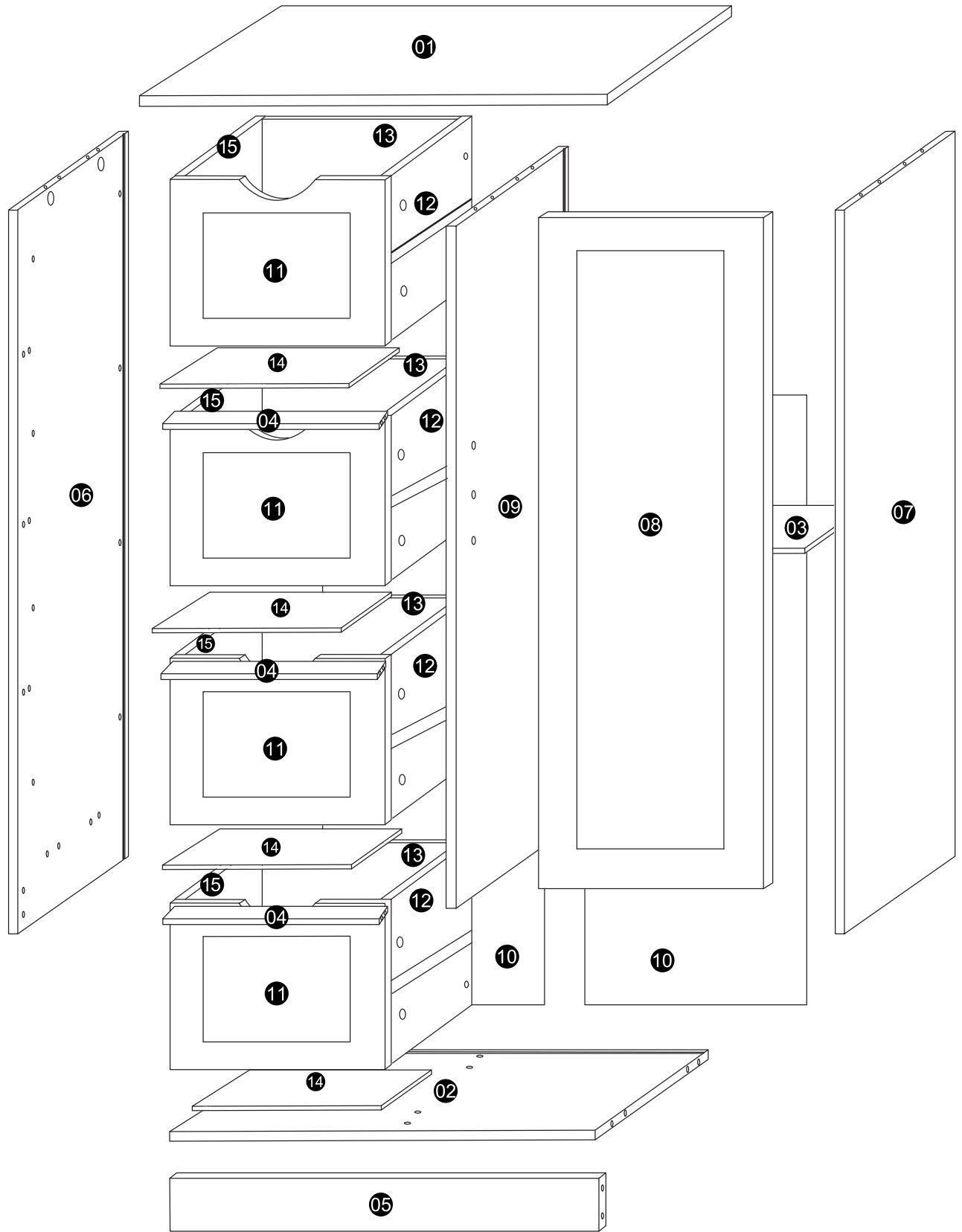









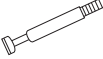
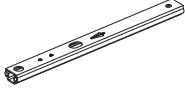





Tools Required:

- Phillips screwdriver

Parts List:

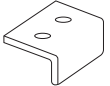
a  X20	b  X34	c  X34	d  X8	e  X12
f  X2	g  X1	h  X4	j  X18	m  X16
n  X3	o  X1	p  X1	q  X1	s  X8
t  X2	u  X1			

Assembly Instructions:

STEP 1A

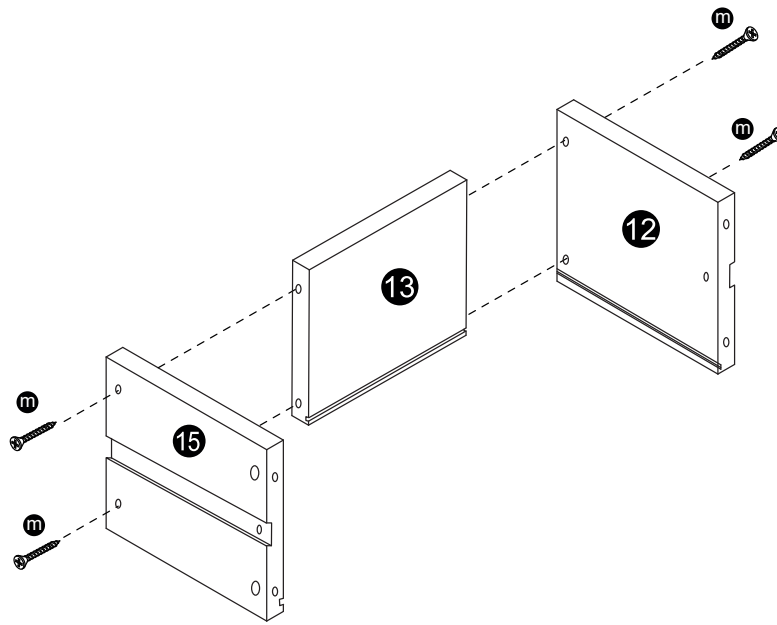

x4

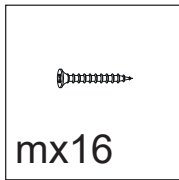

STEP 1B

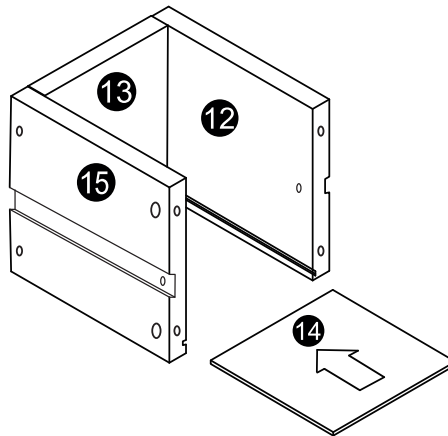

x4

STEP 1C

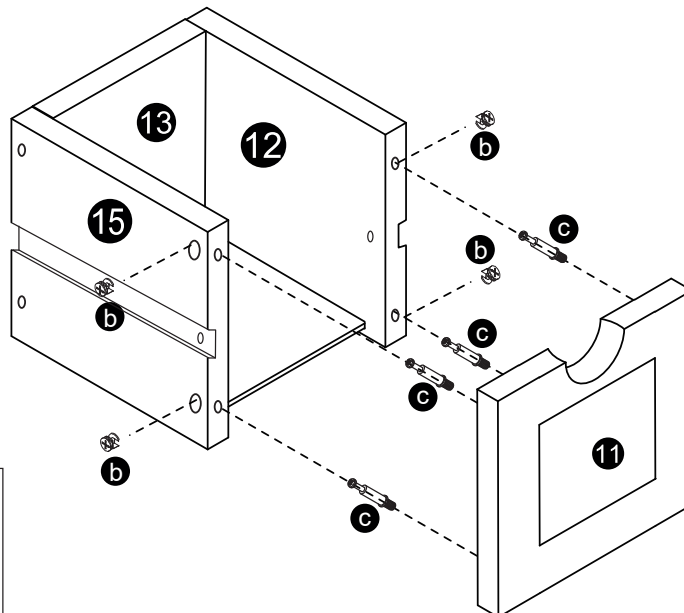

x4

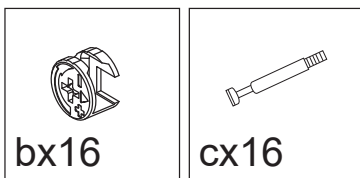

STEP 2

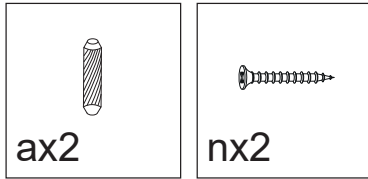
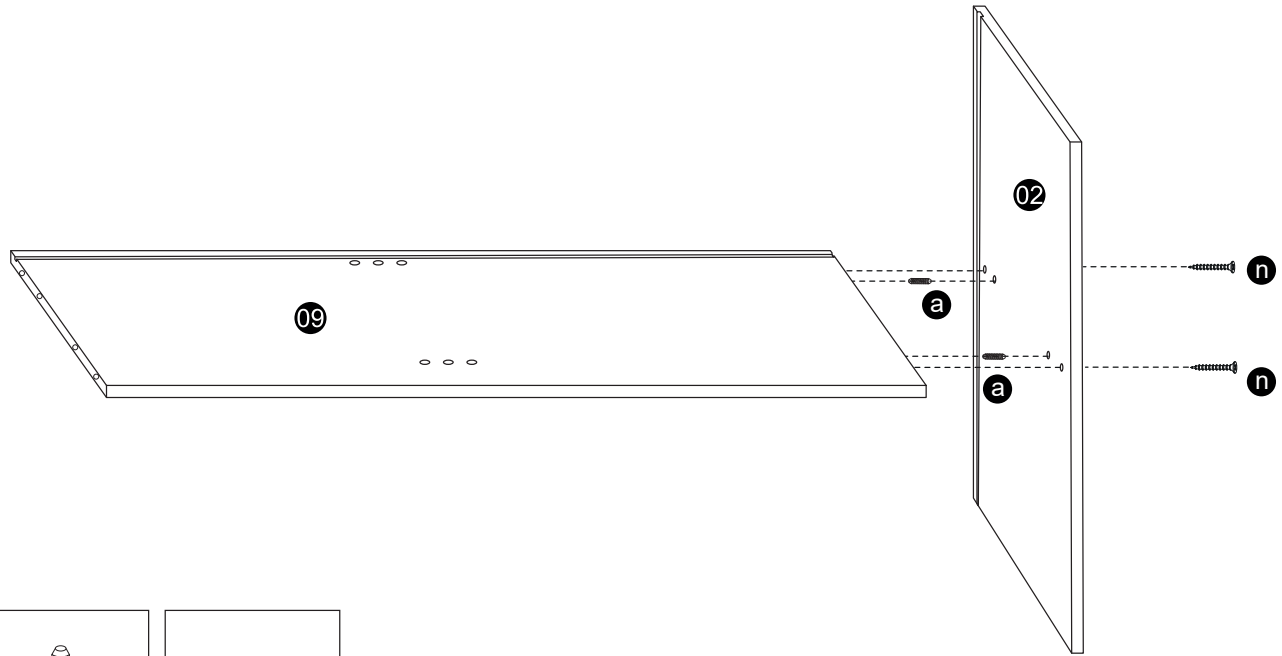

STEP 3A

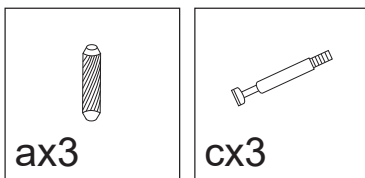
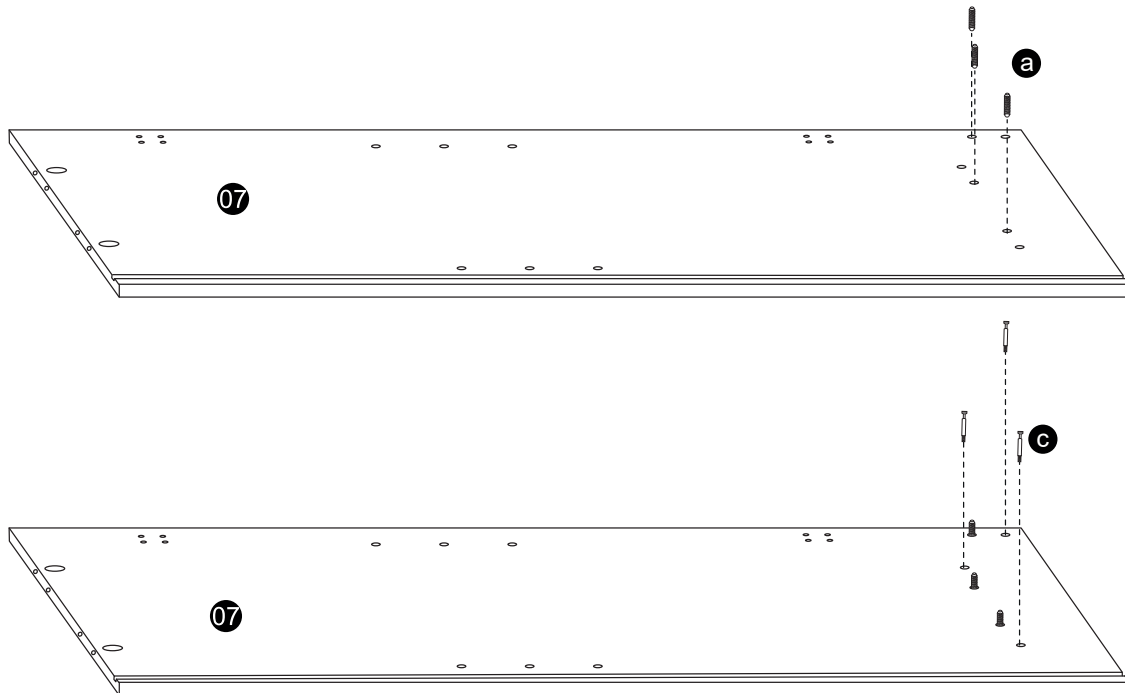

STEP 3B

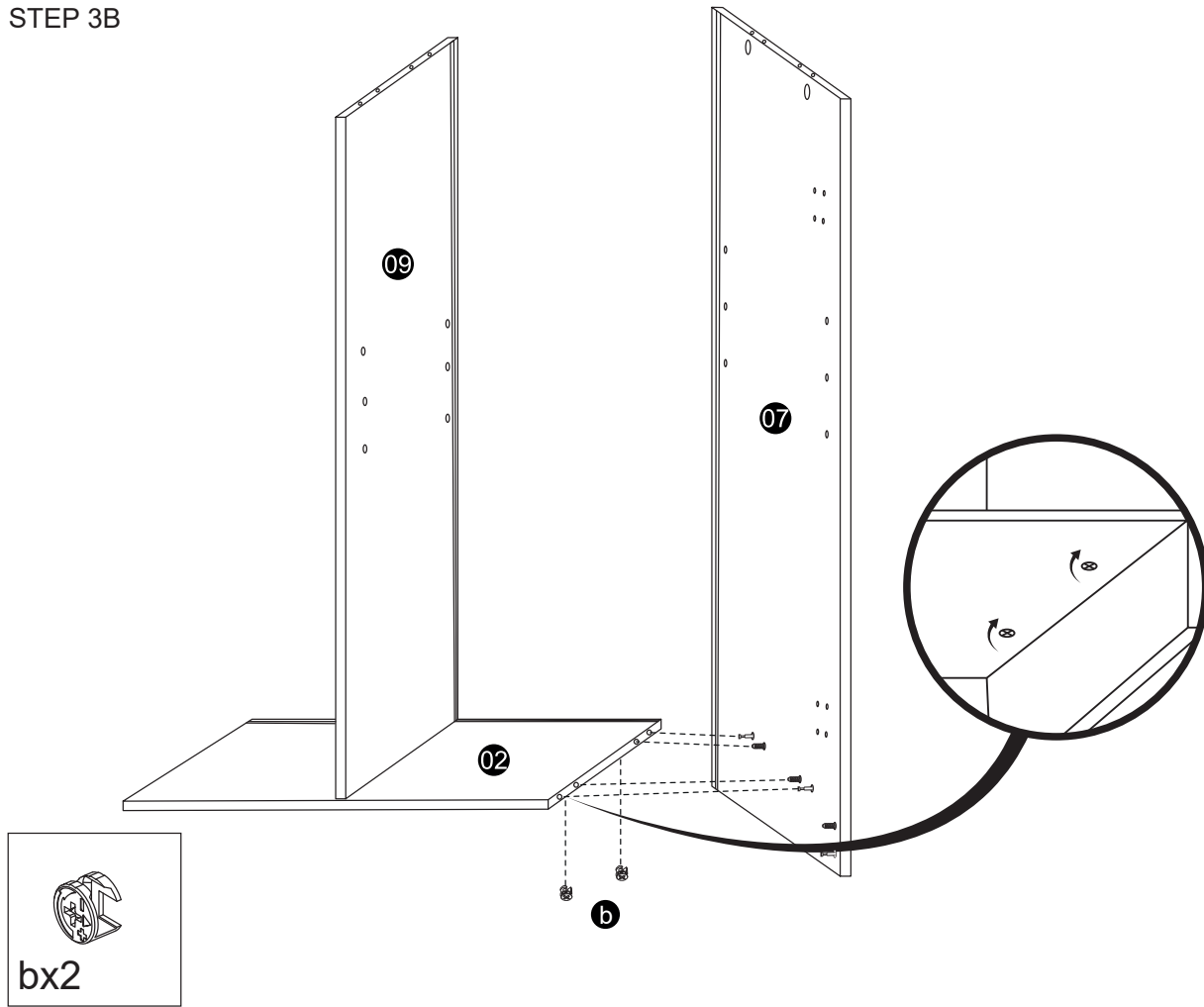

STEP 4

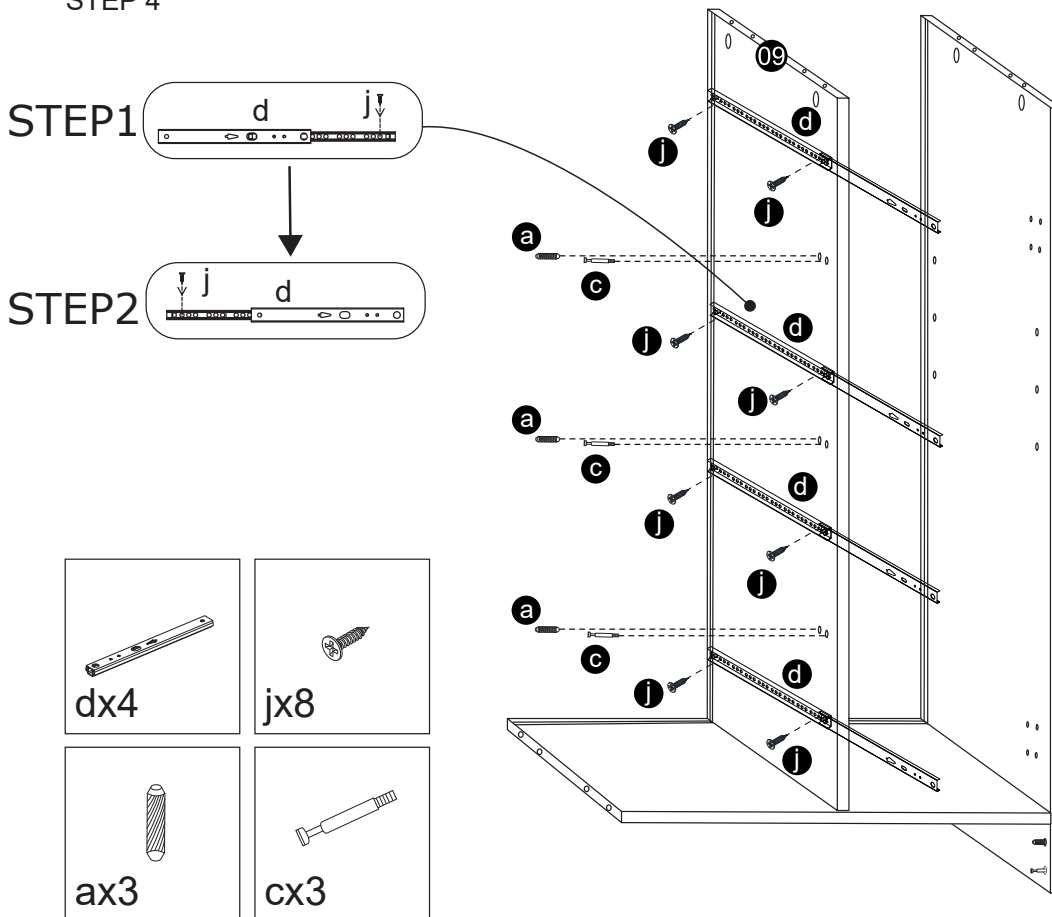

STEP 5

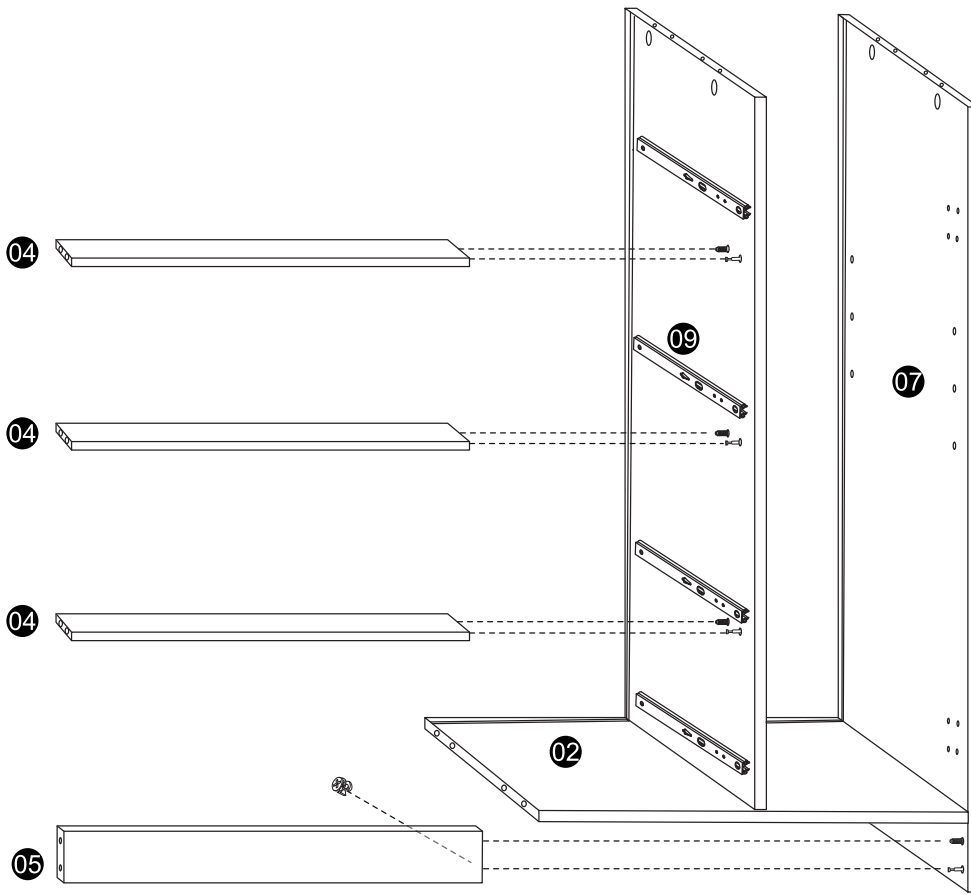
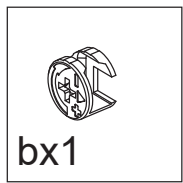

STEP 6A

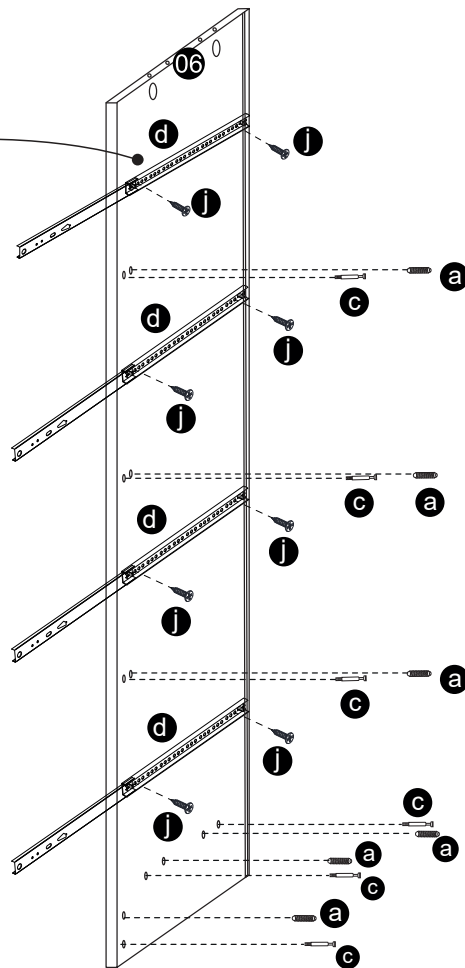
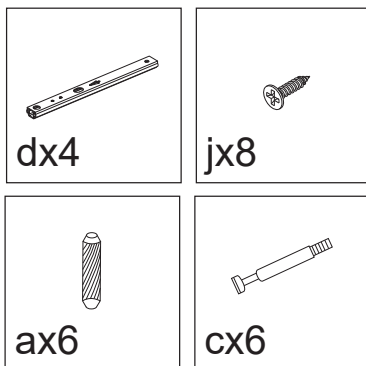
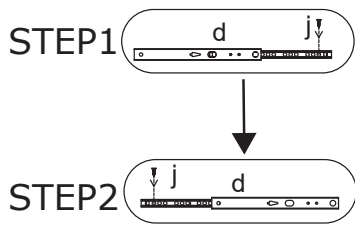

STEP 6B

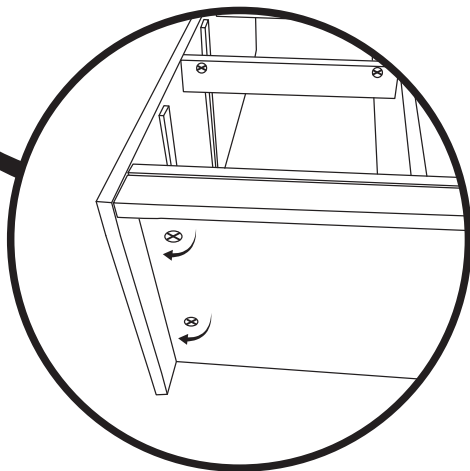
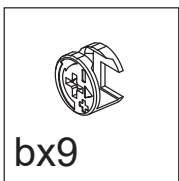
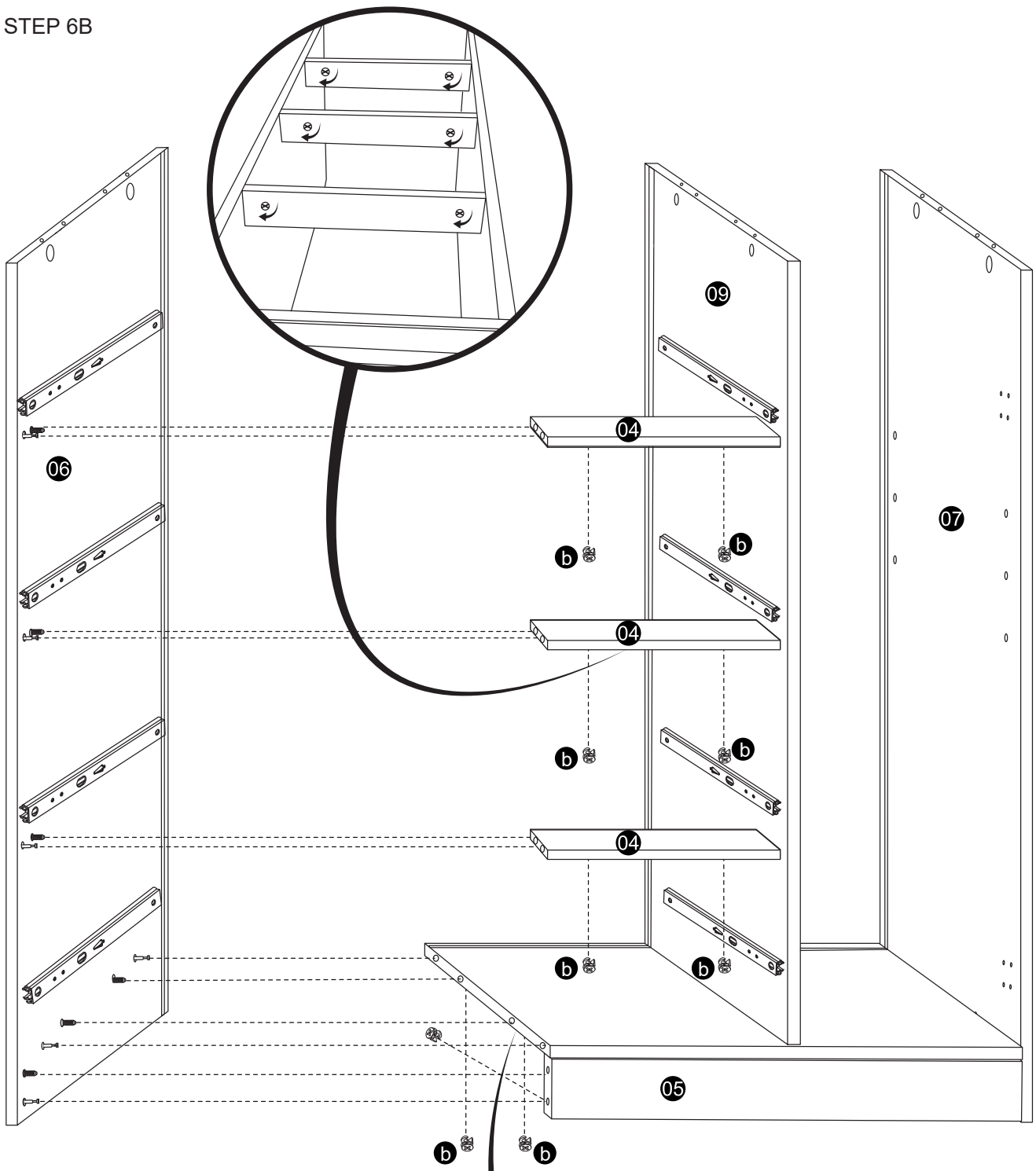

STEP 7

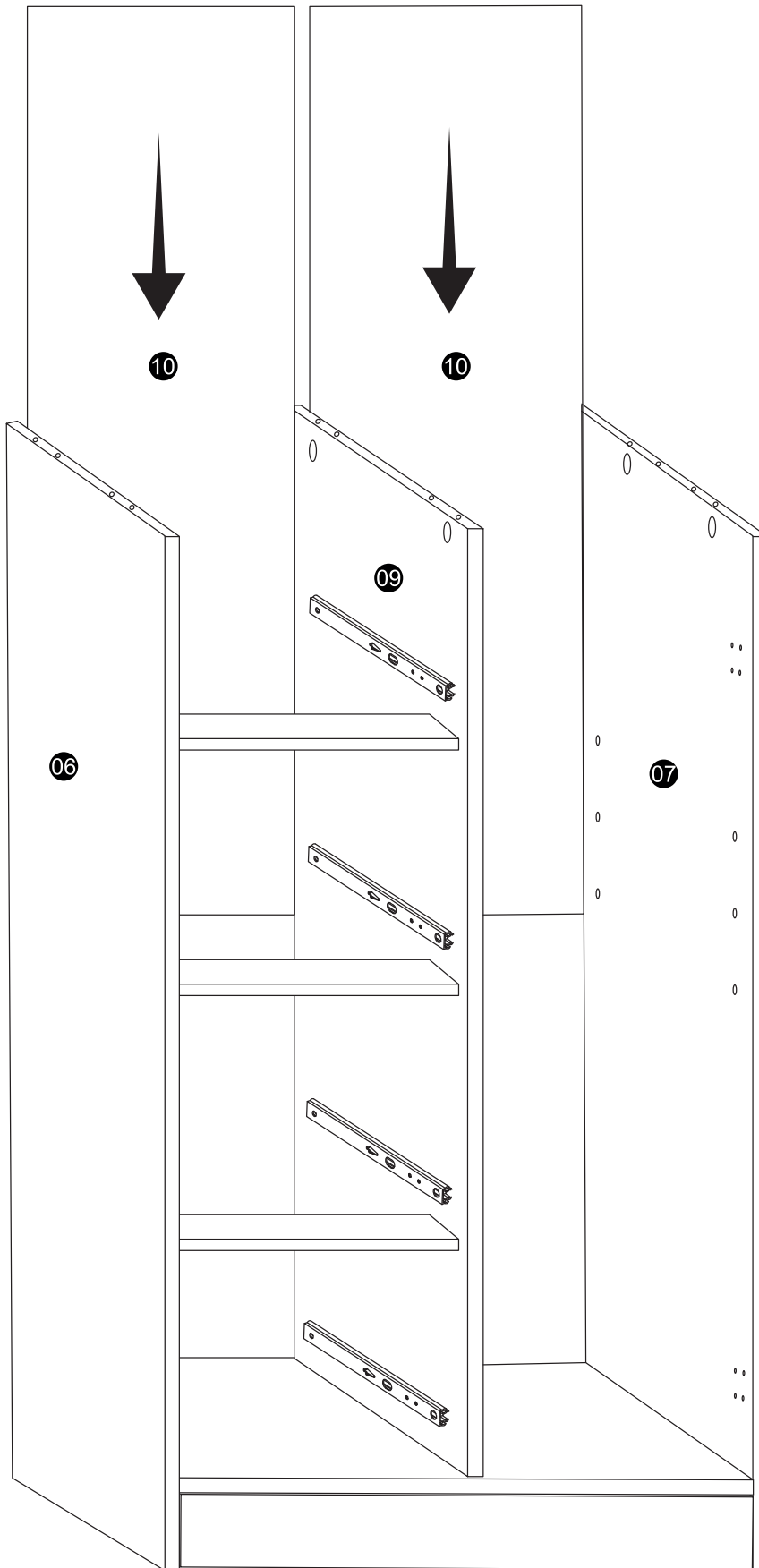

STEP 8

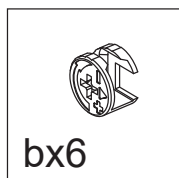
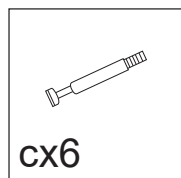
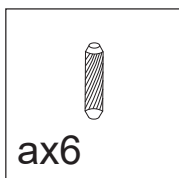
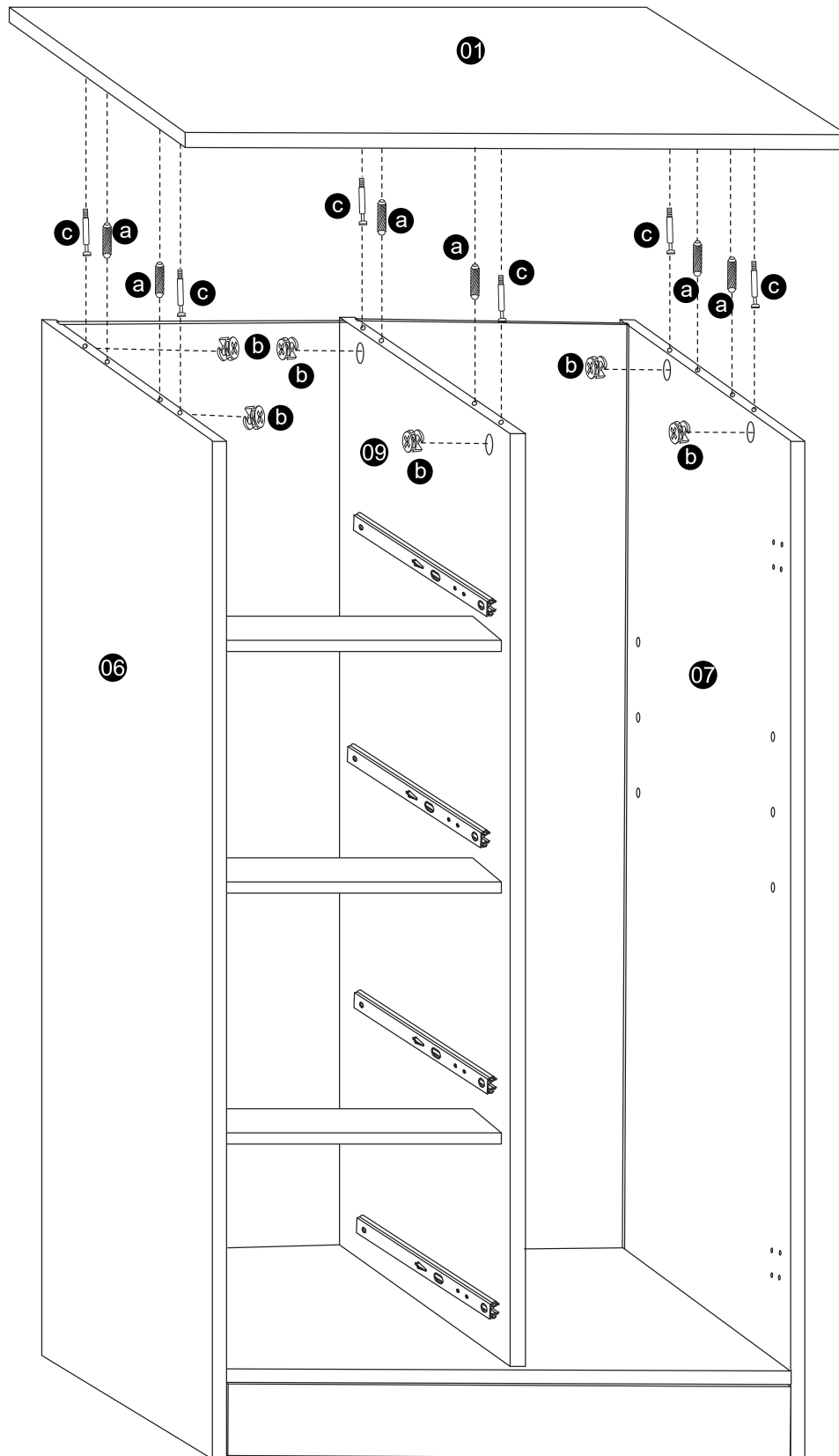

STEP 9A

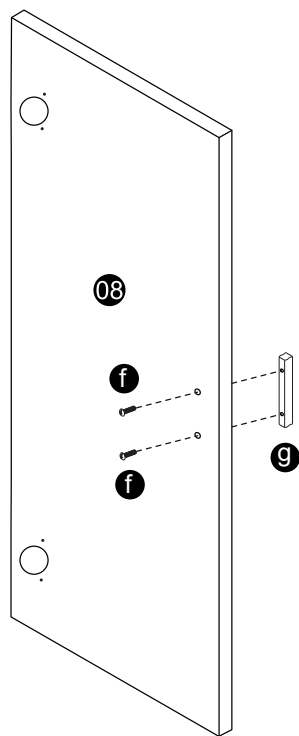

STEP 9B

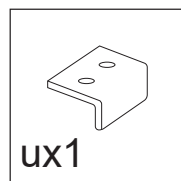
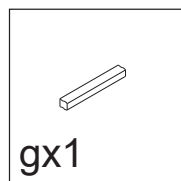
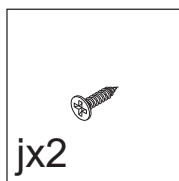
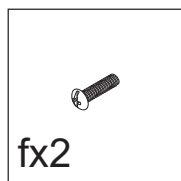
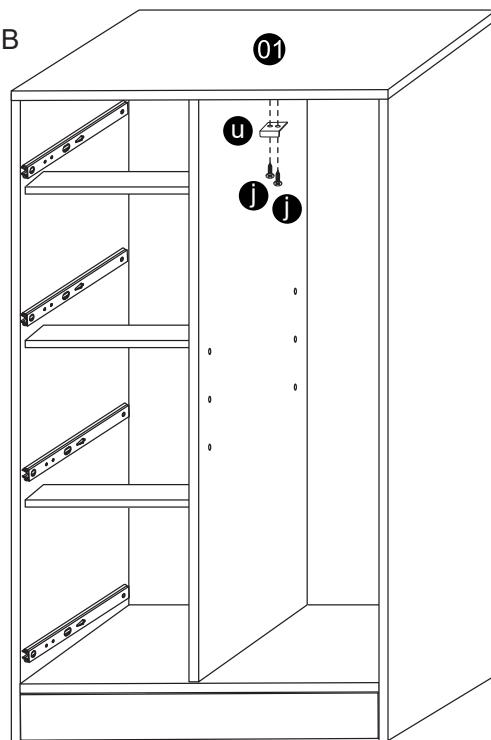

STEP 10

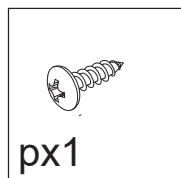
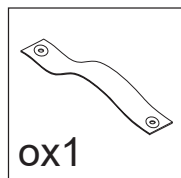
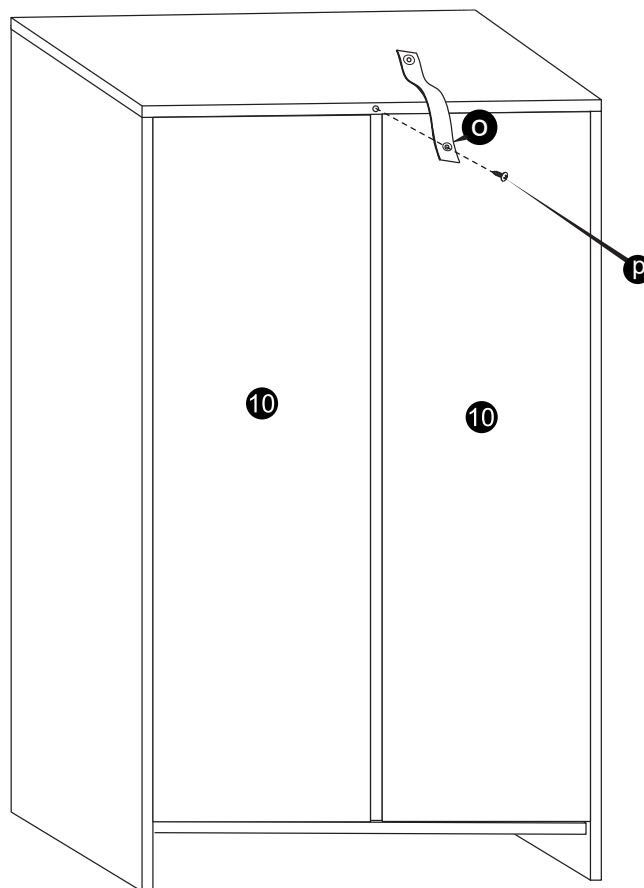

STEP 11A

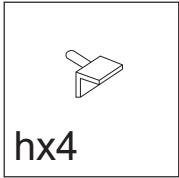
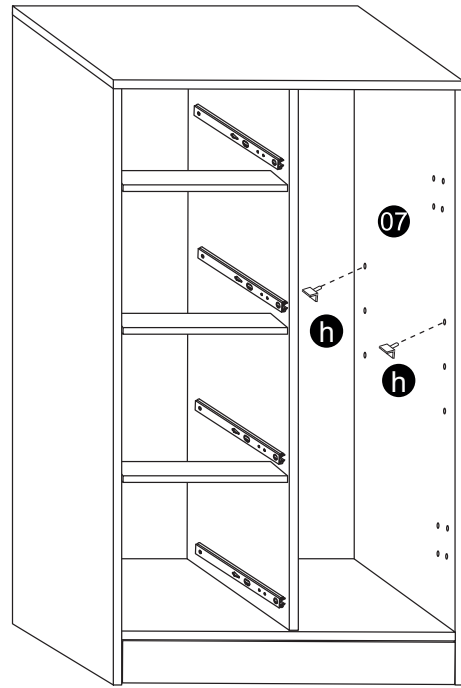
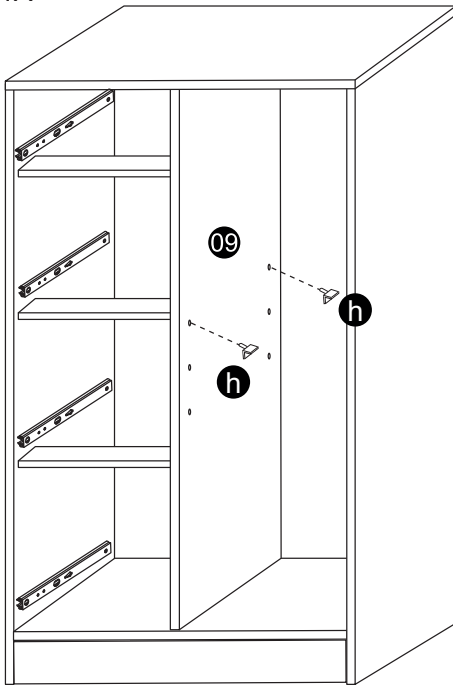

STEP 11B

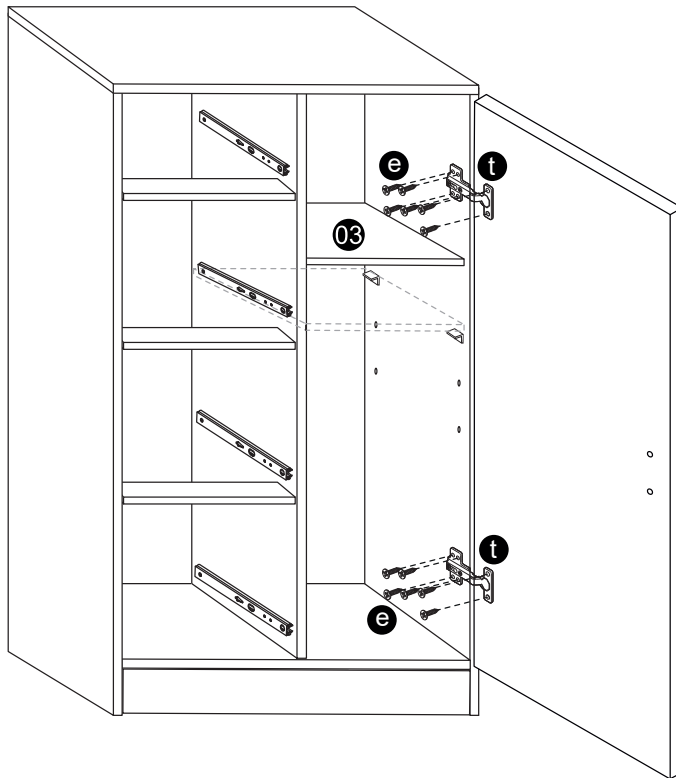

STEP 11C

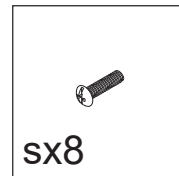
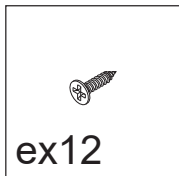
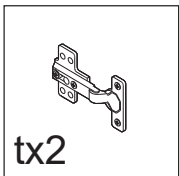
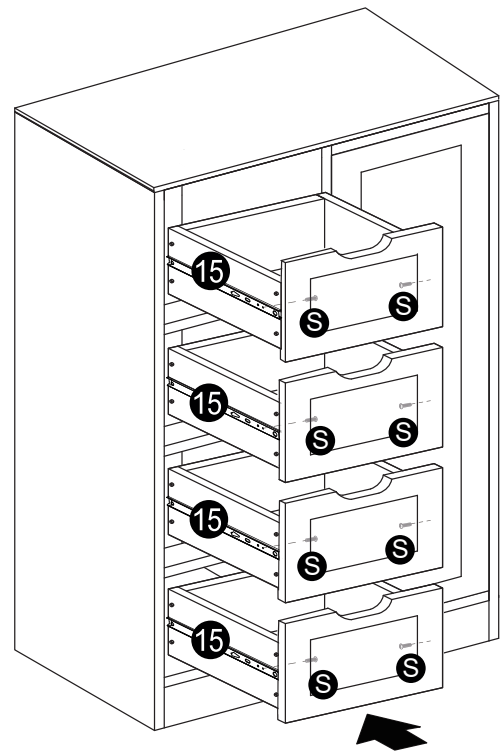

STEP 12

